

JVC

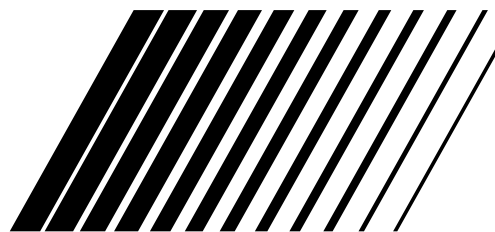

POWERED WOOFER CD-MD SYSTEM

RD-MD5

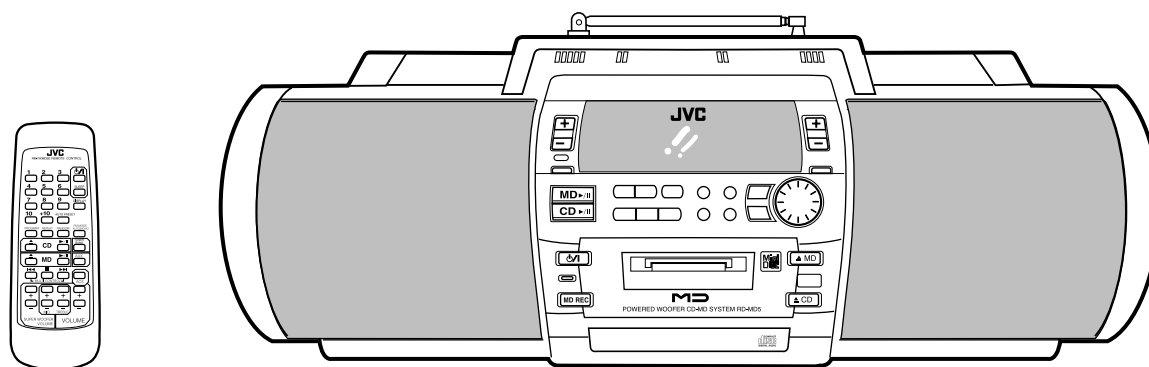

INSTRUCTIONS

For Customer Use:
Enter below the Model No. and Serial No. which are located either on the rear, bottom or side of the cabinet. Retain this information for future reference.

Model No. _____

Serial No. _____

LVT0107-006A
[B]

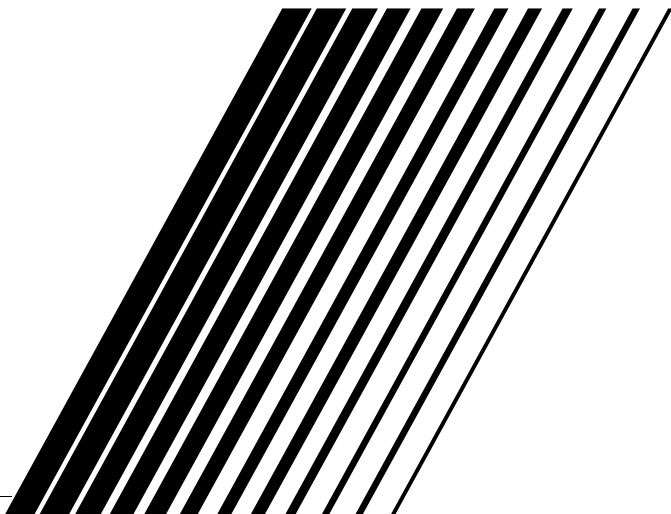

Warnings, Cautions and Others

IMPORTANT for the U.K.

DO NOT cut off the mains plug from this equipment. If the plug fitted is not suitable for the power points in your home or the cable is too short to reach a power point, then obtain an appropriate safety approved extension lead or consult your dealer.

BE SURE to replace the fuse only with an identical approved type, as originally fitted.

If nonetheless the mains plug is cut off ensure to remove the fuse and dispose of the plug immediately, to avoid a possible shock hazard by inadvertent connection to the mains supply.

If this product is not supplied fitted with a mains plug then follow the instructions given below:

IMPORTANT:

DO NOT make any connection to the terminal which is marked with the letter E or by the safety earth symbol or coloured green or green-and-yellow.

The wires in the mains lead on this product are coloured in accordance with the following code:

Blue : Neutral
Brown : Live

As these colours may not correspond with the coloured markings identifying the terminals in your plug proceed as follows:

The wire which is coloured blue must be connected to the terminal which is marked with the letter N or coloured black.

The wire which is coloured brown must be connected to the terminal which is marked with the letter L or coloured red.

IF IN DOUBT - CONSULT A COMPETENT ELECTRICIAN.

IMPORTANT FOR LASER PRODUCTS

REPRODUCTION OF LABELS

- 1 CLASSIFICATION LABEL, PLACED ON EXTERIOR SURFACE

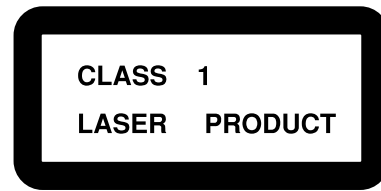

- 2 WARNING LABEL, PLACED INSIDE THE UNIT

DANGER: Invisible laser radiation when open and interlock failed or defeated. AVOID DIRECT EXPOSURE TO BEAM. (e)

WARNING: Osynlig laserstrålning när denna del är öppnad och spärren är urkopplad. Beträkta ej strålen. (s)

ADVARSEL: Usynlig laserstrålning ved åbning, når sikkerhedsafbrydere er ude af funktion. Undgå udsættelse for stråling (d)

VARO: Avattaessa ja suo-
jalukitus ohitettaessa olet
alttiina näkymättömälle
lasersäteilylle. Älä katso
säteeseen. (f)

- 1 CLASS 1 LASER PRODUCT
- 2 **DANGER:** Invisible laser radiation when open and interlock failed or defeated. Avoid direct exposure to beam.
- 3 **CAUTION:** Do not open the top cover. There are no user serviceable parts inside the Unit; leave all servicing to qualified service personnel.

Caution — ϕ /I switch!

Disconnect the mains plug to shut the power off completely. The ϕ /I switch in any position does not disconnect the mains line. The power can be remote controlled.

CAUTION

To reduce the risk of electrical shocks, fire, etc.:

- 1 Do not remove screws, covers or cabinet.
- 2 Do not expose this appliance to rain or moisture.

Caution: Proper Ventilation

To avoid risk of electric shock and fire, and to prevent damage, locate the apparatus as follows:

- 1 Front: No obstructions and open spacing.
- 2 Sides/ Top/ Back: No obstructions should be placed in the areas shown by the dimensions below.
- 3 Bottom: Place on the level surface. Maintain an adequate air path for ventilation by placing on a stand with a height of 10 cm or more.

Front view

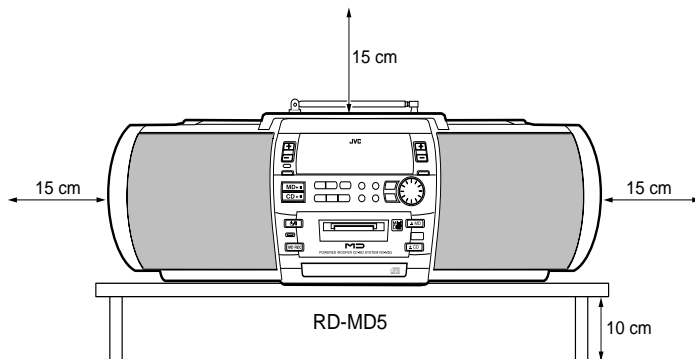

Side view

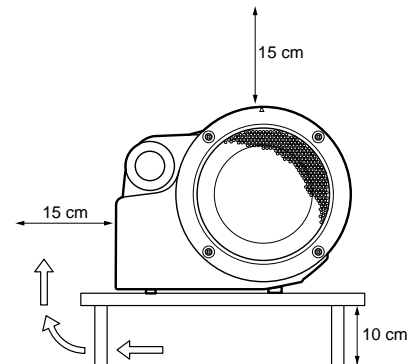

SAFETY INSTRUCTIONS "SOME DOS AND DON'TS ON THE SAFE USE OF EQUIPMENT"

This equipment has been designed and manufactured to meet international safety standards but, like any electrical equipment, care must be taken if you are to obtain the best results and safety is to be assured.

Do read the operating instructions before you attempt to use the equipment.

Do ensure that all electrical connections (including the mains plug, extension leads and interconnections between pieces of equipment) are properly made and in accordance with the manufacturer's instructions. Switch off and withdraw the mains plug when making or changing connections.

Do consult your dealer if you are ever in doubt about the installation, operation or safety of your equipment.

Do be careful with glass panels or doors on equipment.

DON'T continue to operate the equipment if you are in any doubt about it working normally, or if it is damaged in any way—switch off, withdraw the mains plug and consult your dealer.

DON'T remove any fixed cover as this may expose dangerous voltages.

DON'T leave equipment switched on when it is unattended unless it is specifically stated that it is designed for unattended operation or has a standby mode. Switch off using the switch on the equipment and make sure that your family know how to do this.

Special arrangements may need to be made for infirm or handicapped people.

DON'T use equipment such as personal stereos or radios so that you are distracted from the requirements of traffic safety. It is illegal to watch television whilst driving.

DON'T listen to headphones at high volume as such use can permanently damage your hearing.

DON'T obstruct the ventilation of the equipment, for example with curtains or soft furnishings.

Overheating will cause damage and shorten the life of the equipment.

DON'T use makeshift stands and NEVER fix legs with wood screws — to ensure complete safety always fit the manufacturer's approved stand or legs with the fixings provided according to the instructions.

DON'T allow electrical equipment to be exposed to rain or moisture.

ABOVE ALL

- NEVER let anyone, especially children, push anything into holes, slots or any other opening in the case -this could result in a fatal electrical shock.;
- NEVER guess or take chances with electrical equipment of any kind
- it is better to be safe than sorry!

Thank you for purchasing the JVC Powered Woofer CD-MD System.
 We hope it will be a valued addition to your home, giving you years of enjoyment.
 Be sure to read this instruction manual carefully before operating your new stereo system.
 In it you will find all the information you need to set up and use the system.
 If you have a query that is not answered by the manual, please contact your dealer.

Features

Here are some of the things that make your System both powerful and simple to use.

- The controls and operations have been redesigned to make them very easy to use, freeing you to just enjoy the music.
 - With JVC's **COMPU PLAY** you can turn on the System and automatically start the Radio, CD Player, MD Player with a single touch.
- The System is equipped with 10-cm dia. super woofers that provide powerful bass.
- The System incorporates an Active Clear Sound circuitry to provide clear high frequency sounds in conjunction with the bass level.
- A 45-station preset capability (30 FM and 15 AM (MW/LW)) in addition to auto-seek and manual tuning.
- Versatile CD options include repeat, random and program play.
- Versatile MD Player provides playback function, recording function, editing function of the tracks in the MD, title function to give title to the MD and tracks.
- Timer functions; set the system to automatically come on, switch off.



How This Manual Is Organized

- Basic information that is the same for many different functions - e.g. setting the volume - is given in the section 'Common Operations', and not repeated under each function.
- The names of buttons/controls and display messages are written in all capital letters: e.g. TUNER BAND, "CD NO DISC".
- System functions are written with an initial capital letter only: e.g. Normal Play.

Use the table of contents to look up specific information you require.

We've enjoyed making this manual for you, and hope it serves you in enjoying the many features built into your System.

IMPORTANT CAUTIONS

1. Where to place the System

- Select a place which is level, dry and neither too hot nor too cold. (Between 5°C and 35°C or 41°F and 95°F.)
- Leave sufficient distance between the System and a TV.
- Do not use the System in a place subject to vibrations.

2. Power cord

- Do not handle the power cord with wet hands!
- Some power is always consumed as long as the power cord is connected to the wall outlet.
- When unplugging the System from the wall outlet, always pull the plug, not the power cord.

3. When carrying the System

- Remove a CD on the tray.
- Disconnect all the cords from the System.

4. Malfunctions, etc.

- There are no user serviceable parts inside. In case of system failure, unplug the power cord and consult your dealer.
- Do not insert any metallic object into the System.

Table of Contents

Features	1	Using the Timers	21
How This Manual Is Organized	1	Information on MDs (Minidisks).....	22
IMPORTANT CAUTIONS	1	MD Messages	23
Getting Started	2	Minidisc limitations.....	24
Common Operations	5	Rules of Digital Dubbing.....	24
Using the Tuner	7	Care And Maintenance	25
Using the CD Player	9	Troubleshooting	25
Using the MD Player (Listening to an MD).....	11	Specifications	26
Recording onto an MD.....	14		
Using the MD Player (Editing)	15		
Listening to an Auxiliary Equipment.....	20		

Getting Started

Accessories

Check that you have all of the following items, which are supplied with the System.

- Power Cord (1)
- AM Loop Antenna (1)
- Remote Control (1)
- Batteries (2)

If any of these items are missing, contact your dealer immediately.

How To Put Batteries In the Remote Control

Match the polarity (+ and -) on the batteries with the + and - markings in the battery compartment.

R6P(SUM-3)/AA(15F)

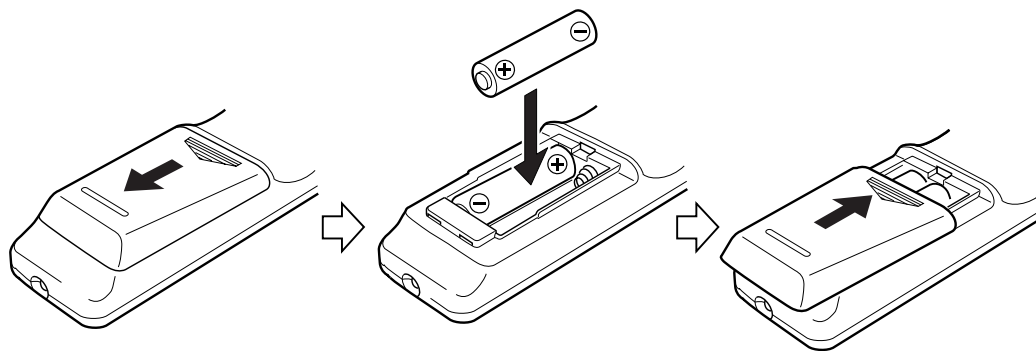

CAUTION: Handle batteries properly.

To avoid battery leakage or explosion:

- Remove batteries when the Remote Control will not be used for a long time.
- When you need to replace the batteries, replace both batteries at the same time with new ones.
- Don't use an old battery with a new one.
- Don't use different types of batteries together.

Using the Remote Control

The Remote Control makes it easy to use many of the functions of the System from a distance of up to 7m (23 feet) away. You need to point the Remote Control at the remote sensor on the System's front panel.

Note: If you point the Remote Control from the slant direction, the above distance will be shortened.

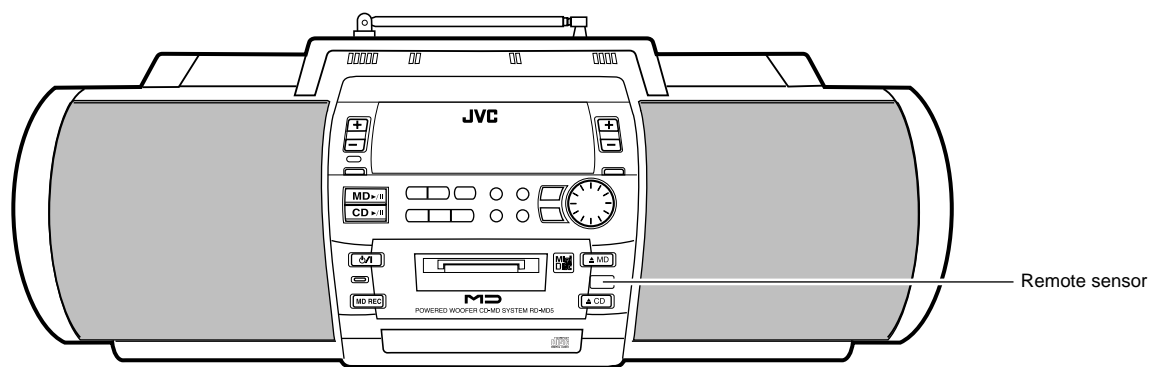

CAUTION: Make all connections before plugging the System into an AC power outlet.

Connecting the FM Antenna

FM broadcast reception is made with the telescopic antenna. Fully extend and turn it to obtain the best reception.

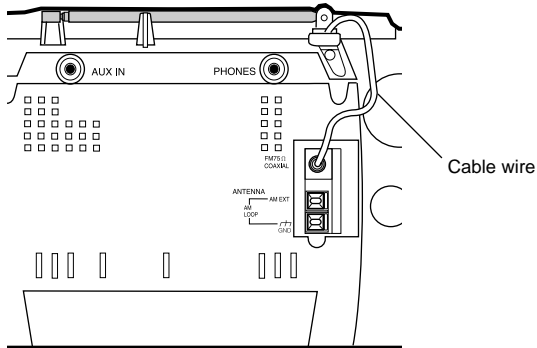

If reception is poor, connect an FM outside antenna (not supplied) as follows.

Disconnect the cable wire from the FM 75-ohm COAXIAL terminal on the back of the System. Then, connect a 75-ohm antenna with coaxial type connector (IEC or DIN45 325) to the FM 75-ohm COAXIAL terminal.

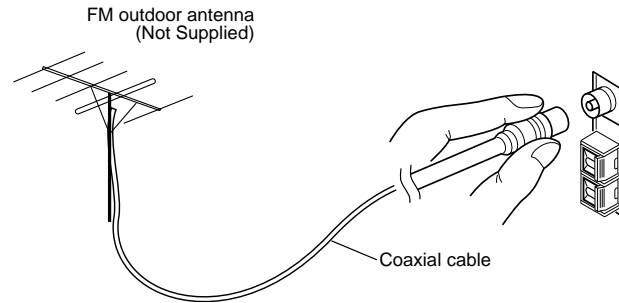

CAUTION: To avoid noise, keep antennas away from the System, the connecting cord and the AC power cord.

Connecting the AM (MW/LW) Antenna

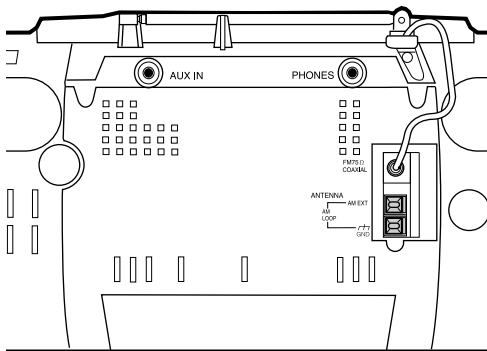

AM loop antenna (Supplied)

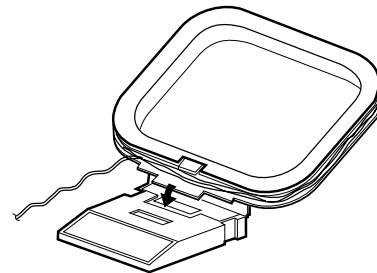

Attach the AM loop to its base by snapping the tabs on the loop into the slot in the base.

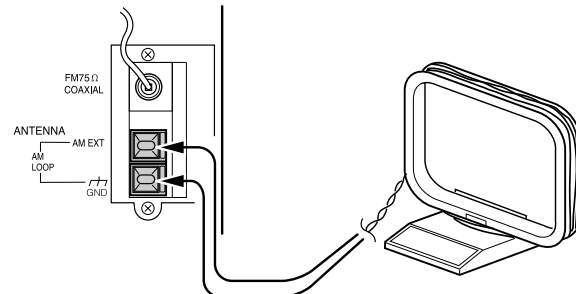

Turn the loop until you have the best reception.

CAUTION: Make all connections before plugging the System into an AC power outlet.

Connecting Auxiliary Equipment

Connect an (not supplied) signal cord between the AUX IN terminal on the System and the output terminals of your auxiliary equipment (e.g. turntable). You can listen to this source.

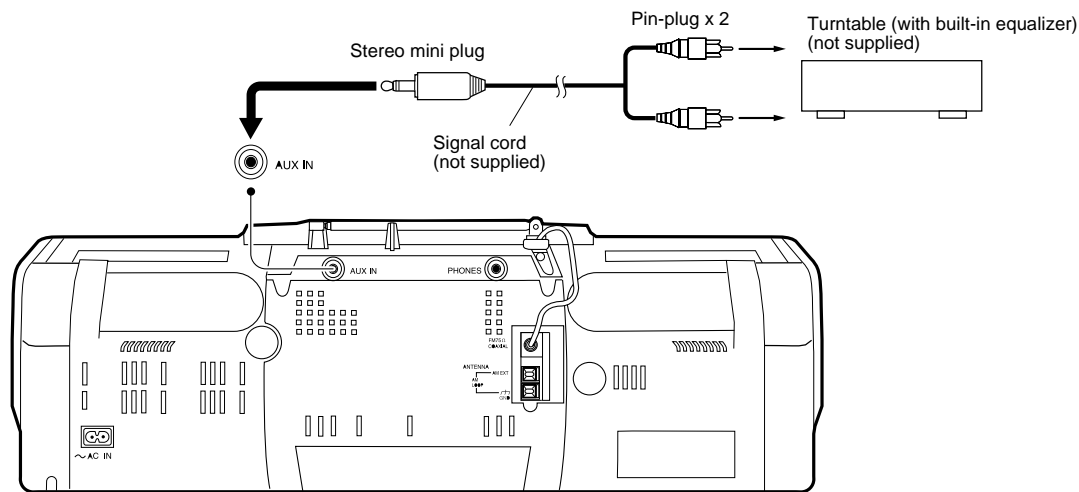

Connecting the AC Power Cord

Firmly insert the supplied AC power cord into the AC inlet on the back of the Unit.

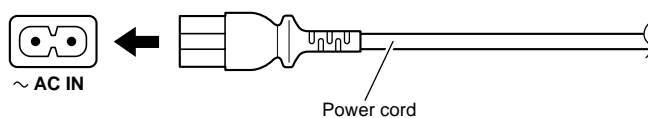

CAUTIONS:

- **ONLY USE THE JVC POWER CORD PROVIDED WITH THIS SYSTEM TO AVOID MALFUNCTION OR DAMAGE TO THE SYSTEM.**
- **BE SURE TO UNPLUG THE POWER CORD FROM THE OUTLET WHEN GOING OUT OR WHEN THE SYSTEM IS NOT IN USE FOR AN EXTENDED PERIOD OF TIME.**

Now you can plug the AC power cord into the wall outlet, and your System is at your command!!

COMPU PLAY

JVC's COMPU PLAY feature lets you control the most frequently used System functions with a single touch.

With One Touch Operation you can play a CD, an MD, or turn on the radio with a single press of the play button for that function. One Touch Operation turns the power on for you, then starts the function you have specified. If the System is not ready (no CD in place, for example), the System still powers on so you can insert a CD.

How One Touch Operation works in each case is explained in the section dealing with that function.

The COMPU PLAY buttons are:

On the Unit

- CD ▶/|| button
- TUNER BAND button
- MD ▶/|| button
- AUX button

On the Remote Control

- CD ▶/|| button
- TUNER BAND button
- MD ▶/|| button
- AUX button

Common Operations

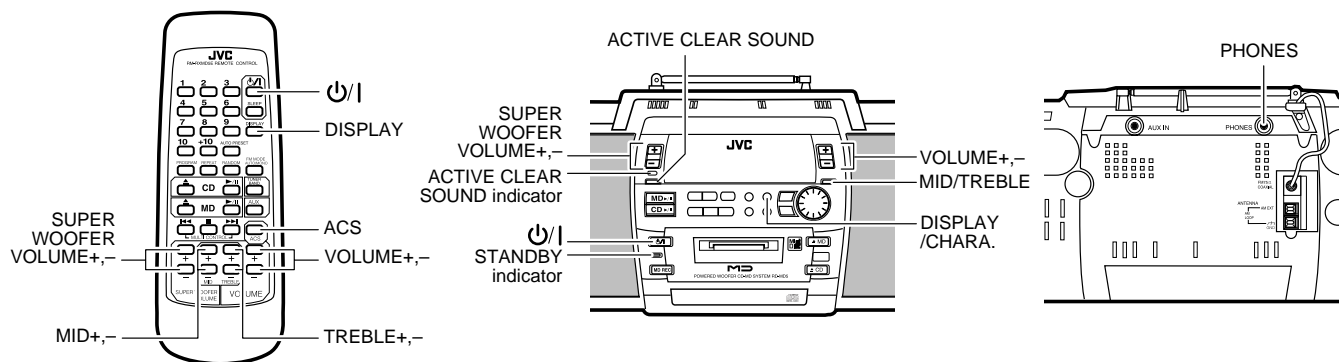

Turning the Power On and Off

Turning the System On

Press the **power** button.

The display comes on and the "STANDBY" indicator goes out. The System comes on ready to continue in the mode it was in when the power was last turned off.



- For example, if the last thing you were doing was listening to a CD, you are now ready to listen to a CD again. If you wish, you can change to another source.
- If you were listening to the Tuner last, the Tuner comes on playing the station it was last set to.

Turning the System Off

Press the **power** button again.

The "STANDBY" indicator lights up and the display is blank, except for the clock display.



- Some power is always consumed even though power is turned off (called Standby Mode).
- To switch off the System completely, unplug the AC power cord from the AC outlet. When you unplug the AC power cord, the clock will be reset to 0:00 after about 5 minutes, and preset Tuner stations will be erased after about 24 hours.

Adjusting the Volume

You can adjust the volume level between 0 and 50.

Press the **VOLUME +** button to increase the volume or press the **VOLUME -** button to decrease it. When you keep pressed the **VOLUME +** or **-** button, the **VOLUME** indication changes rapidly.



CAUTION: DO NOT start playing any source without first setting the VOLUME control to minimum position, as a sudden blast of sound can damage your hearing, speakers and/or headphones.

5

For private listening

Connect a pair of headphones to the PHONES jack. No sound comes out of the speakers.

Be sure to turn down the volume before connecting or putting on headphones.

Adjusting the Super Woofer Volume

You can adjust the bass level between **BASS 1** (minimum) and **BASS 6** (maximum). You can use this effect only for playback.

Press the **SUPER WOOFER VOLUME +** button to increase the bass level or press the **SUPER WOOFER VOLUME -** button to decrease it.

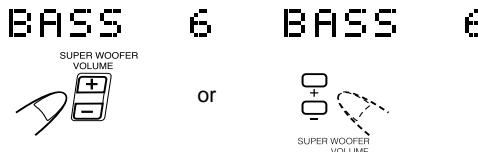

Note: This function is not effective when the headphones are in use.

Tone Control (MID/TREBLE)

You can control the tone by changing the mid and the treble between **-6** and **+6**. (0: Flat)

Using the Unit

1. Press the MID/TREBLE button to select MID or TREBLE.

Each time you press the button, the display changes as follows.

Current sound source (e.g. FM103.50MHz) → **MID 0** → **TREBLE 0** → (back to the beginning)

2. Press the VOLUME + or - button within 4 seconds to adjust the mid/treble level.

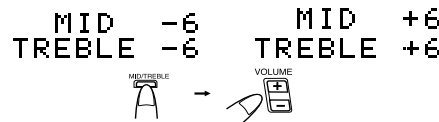

Using the Remote Control

Press the **MID+** or **MID-** button to adjust the mid level between **MID -** and **MID +6**.

Press the **TREBLE+** or **TREBLE-** button to adjust the treble level between **TREBLE -** and **TREBLE +6**.

ACS (Active Clear Sound) Effect

The Active Clear Sound circuitry emphasizes the high frequency range level in conjunction with the bass level so that you can obtain clear sound at high frequencies. You can use this effect only for playback.

To get the effect, press the ACTIVE CLEAR SOUND button on the Unit or the ACS button on the Remote Control.

The "ACS" indicator lights up and "ACS ON" appears on the display for 3 seconds.

The "ACTIVE CLEAR SOUND LEVEL" indicator on the Unit will light when the Active Clear Sound effect is activated because of great bass level.

To cancel the effect, press the same button again.

The "ACS" indicator goes out and "ACS OFF" appears on the display for 3 seconds.



Note: This function is not effective when playing in monaural.

Showing the Time (CLOCK)

While the power is turned on, you can see the current time (clock) at any time.

Press the DISPLAY/CHARA. button on the Unit or the DISPLAY button on the Remote Control. Each time the button is pressed, the display changes as follows.

Current sound source (e.g. FM103.50MHz)→Remaining time of the MD (if an MD is inserted)→Clock→(back to the beginning)

Note: To let work the clock, you need to set the clock beforehand. (See "Setting the Clock" on page 21.)

Using the Tuner

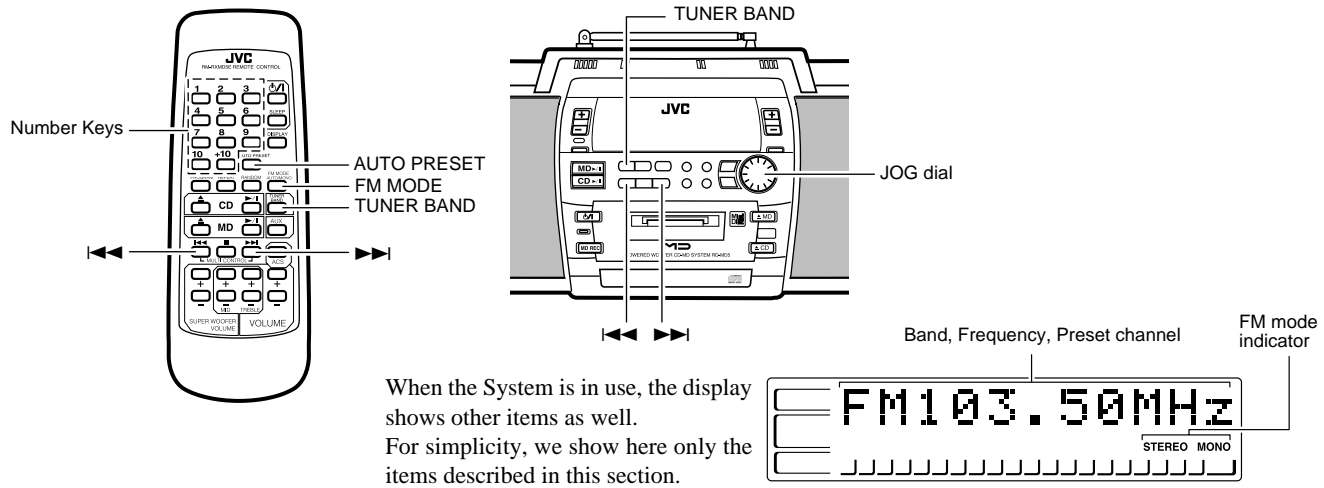

When the System is in use, the display shows other items as well. For simplicity, we show here only the items described in this section.

You can listen to FM and AM (MW/LW) stations. Stations can be tuned in manually, automatically, or from preset memory storage.

- Before listening to the radio:
 - Check that the AM loop antenna is correctly connected. (See page 3).
 - Fully extend the FM telescopic antenna.

One Touch Radio

Just press the TUNER BAND button to turn on the System and start playing the station you were last tuned to.

- You can switch from any other sound source to the radio by pressing the TUNER BAND button.

Tuning In a Station

1. Press the TUNER BAND button.

The Band and Frequency you were last tuned to appear on the display. Each time you press the button, the band alternates between FM and AM (MW/LW).

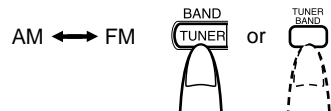

2. Select a station using one of the following methods.

■ Manual Tuning

Press the ◀◀ or ▶▶ button repeatedly to move from frequency to frequency until you find the station you want.

OR

■ Auto Tuning

If you press and hold the ◀◀ or ▶▶ button for one second or more, the frequency changes down, or up, automatically until a station is found.

OR

■ Preset Tuning (Possible only after presetting stations)

Select the desired preset number (displayed as "P XX" on the display) using the JOG dial or the number keys on the Remote control. After 1 second the display will show the preset number's band and frequency.

P 12 → FM103.50MHz
(After 1 second)

JOG dial: Turn it to the right or left to increase or decrease the preset number.

- Number keys: To select P 5, press 5.
To select P 15, press +10 then 5.
To select P 20, press +10 once then press 10.

3. Turn the antenna for best reception.

For an FM broadcast, turn the FM telescopic antenna. If reception is poor, connect an FM outdoor antenna (not supplied) instead of the FM telescopic antenna. (See page 3.)

For an AM (MW/LW) broadcast, place the AM loop antenna for good reception (near the window, for example) and turn it to obtain the best reception.

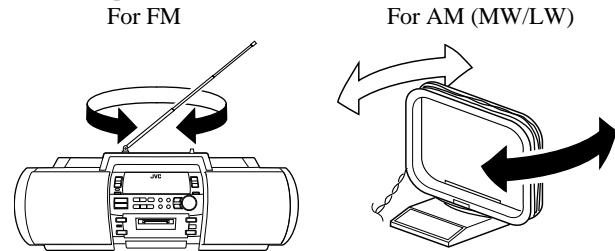

Presetting Stations

Presetting Stations

You can preset up to 30 FM stations and up to 15 AM (MW/LW) stations.

Note: Preset numbers may have been set to factory test frequencies prior to shipment. This is not a malfunction. You can preset the stations you want into memory by following one of the presetting methods below.

Manual Presetting

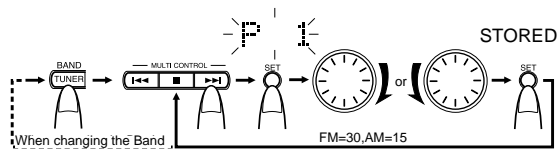

- 1. Select a band by pressing the TUNER BAND button.**
- 2. Press the ◀◀ or ▶▶ button to tune in a station.**
- 3. Press the SET button.**
The youngest blank preset number will blink. "P 1" will blink for the first time.
- 4. Turn the JOG dial to the right or left to select the preset number.**
- 5. Press the SET button.**
"STORED" appears and, after 2 seconds, the display returns to the broadcast frequency display.

- 6. Repeat above steps 1 to 5 for each station you want to store in memory with a preset number.**

To cancel the presetting, press the CANCEL button in step 3 or 4. To change the preset stations, repeat the same steps as above.

Auto Presetting

In each band, you can automatically preset FM-30, AM (MW/LW)-15 stations. Preset numbers will be allocated as stations are found, starting from the lowest station and moving up the frequency.

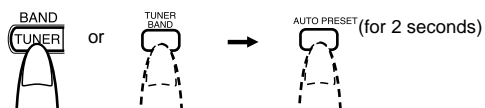

- 1. Select a band by pressing the TUNER BAND button.**
- 2. Press the AUTO PRESET button on the Remote Control for more than two seconds.**
- 3. Repeat steps 1-2 for the other band.**

■ If you want to change the preset stations, carry out the Manual Presetting for the desired preset numbers.

CAUTION: If the System is unplugged or if a power failure occurs, the preset stations will be erased after about 24 hours. If this happens, you will need to preset the stations again.

To Change the FM Reception Mode

When you are tuned in an FM broadcast, the "STEREO" indicator lights up and you can hear stereo effects.

If an FM stereo broadcast is hard to receive or noisy, you can select Monaural mode. Reception improves, but you lose any stereo effect.

Press the FM MODE button on the Remote Control so that the "MONO" indicator lights up on the display.

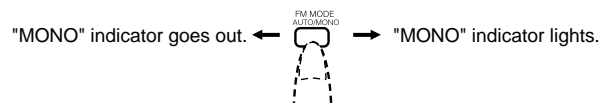

To restore the stereo effect, press the FM MODE button on the Remote Control so the "MONO" indicator goes off.

- If you select other FM station, the "MONO" indicator goes out.

Using the CD Player

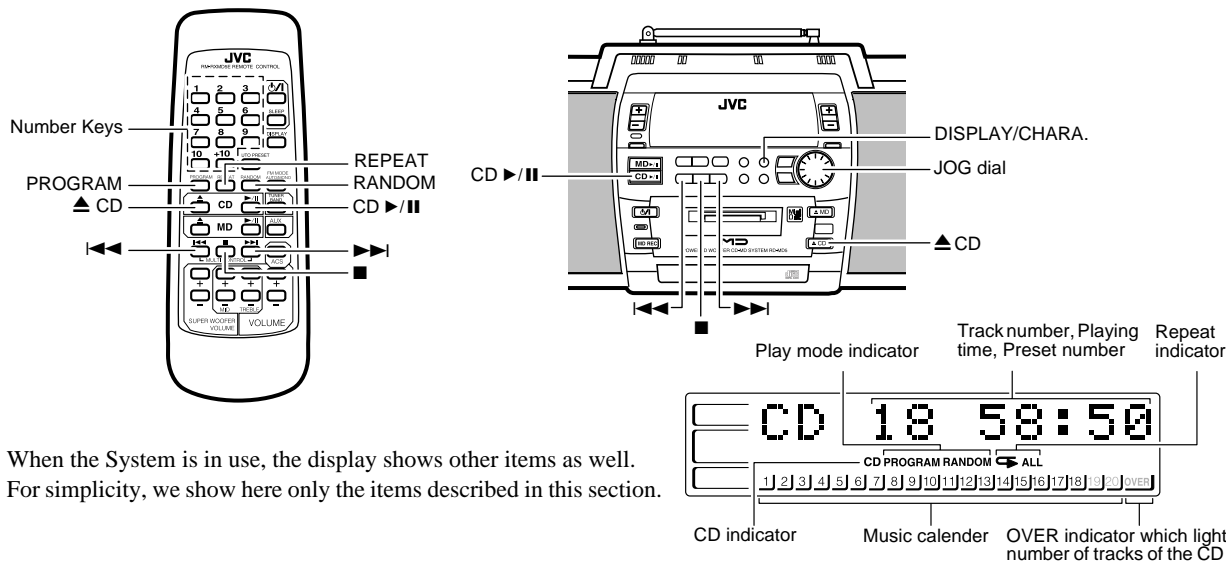

When the System is in use, the display shows other items as well. For simplicity, we show here only the items described in this section.

You can use Normal, Random, Program or Repeat Play. Repeat Play can repeat all the tracks or just one of the tracks on the CD. Here are the basic things you need to know to play a CD and locate the different tracks on it.

The Quickest Way To Start a CD Is With the One Touch Operation

- Press the CD▶/|| button.
- The power is automatically turned on. If a CD is already inserted, it will start playing from the first track.
- If no CD is inserted, "CD NO DISC" appears on the display and the CD Player remains in Stop mode.

To Insert a CD

1. Press the ▲ CD button on the Unit.

The tray opens.

2. Place a CD, with its label side up as shown below.

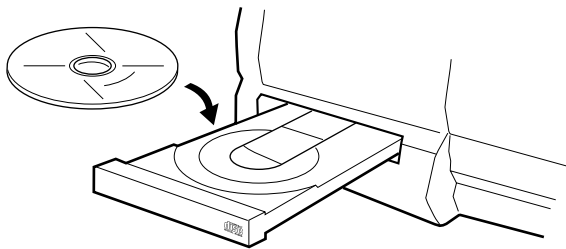

3. Press the ▲ CD button again to close the tray.

- To close the tray and play the CD, you can press the CD▶/|| button.
- When you press the ⏻ button to turn off the System, the tray will be automatically closed, if it is open.
- You can place an 8 cm (3") CD without an adaptor.
- If the CD cannot be read correctly (because it is scratched, for example), "0 0:00" appears on the display.
- You can insert a CD while listening to the other source.

Basics of Using the CD Player-Normal Play

To Play a CD

1. Insert a CD.

2. Press the CD▶/|| button.

The first track of the CD begins playing.

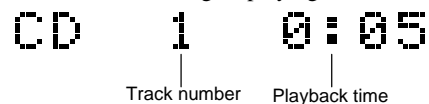

- The track number that has been played disappears from the music calendar.
- The CD Player automatically stops when the last track of the CD has finished playing.

To stop playing the CD, press the ■ button.

The following information for the CD is displayed.

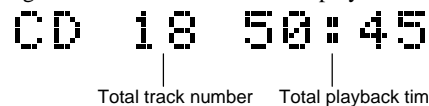

To stop playing and remove the CD, press the ▲ CD button to open the tray.

To pause, press the CD▶/|| button. The playback time blinks on the display.

To cancel pause, press the same button again. Play continues from the point where it was paused.

Locating a Track with Remote Control Directly

During playback or in Stop mode, press the number keys on the Remote Control to directly play a track.

To directly play the track 5, press 5.

To directly play the track 15, press +10 then 5.

To directly play the track 20, press +10 once then press 10.

To Select a Track

During playback, press the ◀◀ or ▶▶ button or turn the JOG dial to select the track you want.

The selected track starts playing.

- Press the ▶▶ button once or turn the JOG dial to the right by 1 click to skip to the beginning of the next track.

- Press the ◀◀ button or turn the JOG dial to the left by 1 click to skip to the beginning of the track being played. Press the ◀◀ button twice quickly or turn the JOG dial to the left by 2 clicks quickly to skip to the beginning of the previous track.
- You can also select a track in Stop mode with the same buttons and the JOG dial.

When the button is pressed or the JOG dial is turned, the selected track and its playback time appear on the display. To play the CD after selecting a track, just press the CD▶/|| button.

Search Play

Holding down the ◀◀ or ▶▶ button, during playback, will fast forward/backwards the CD so you can quickly find a particular passage in the track you are listening to. During Search Play, you can hear the sound of approx. one forth level.

Programming the Playing Order of the Tracks

You can program the playing order of the tracks using the Remote Control.

- You can program up to 20 tracks in any desired order including the same tracks.
- You can only make a program when the CD Player is stopped.

- 1. Insert a CD.**
- 2. Press the CD▶/|| button.**
- 3. Press the ■ button to stop the CD.**
- 4. Press the PROGRAM button.**

The System enters the programming mode and the "PROGRAM" indicator lights up.



- 5. Press the number keys to select the track to program.**

To select the track 5, press 5.
 To select the track 15, press +10 then 5.
 To select the track 20, press +10 once then press 10.

- Example: for track 2, press 2

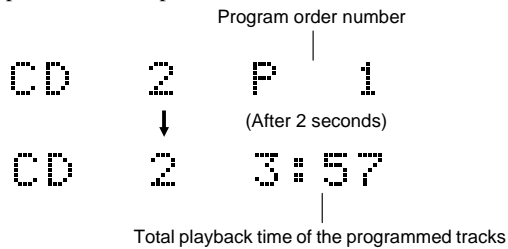

- 6. Repeat step 5 to select the other tracks for the program.**

You can see the total playback time of programmed tracks on the display. Also, you can see the programmed tracks on the music calendar.

To cancel the last track programmed, press the ■ button once.

- 7. Press the CD▶/|| button.**

The System plays the tracks in the order you have programmed them.

- You can skip to a particular program track by pressing the ◀◀ or ▶▶ button or by turning the JOG dial during Program Play.

To confirm the programmed tracks while the CD player is stopped, press the ◀◀ or ▶▶ button or turn the JOG dial; the tracks making up the program will successively be displayed in the programmed order.

To delete all the tracks in the program, press the ■ button repeatedly until all the tracks are cleared. Turning off the power or pressing the ▲CD button to open the tray will also clear the programmed tracks.

To exit Program mode once, while the CD Player is stopped, press the PROGRAM button to light off the "PROGRAM" indicator. To restore Program mode, in Stop mode, press the same button to light on the "PROGRAM" indicator.

Notes:

- If the total playback time of the programmed tracks exceeds 99 minutes 59 seconds, the total playback time will go out on the display.
- When the CD contains more than 21 tracks: When you try to program a track number exceeding 20 (for example the 25th track), the total playback time indication will go out, though programming is possible.

To Modify the Program

Modify the contents of the program while the CD Player is stopped. Each time you press the ■ button, the last track in the program is deleted. To add new tracks to the end of the program, repeat above steps 5 and 6.

Random Play

The tracks will play in no special order when you use this mode.

- 1. Press the RANDOM button on the Remote Control.**

The "RANDOM" indicator lights up on the display.

- 2. Press the CD▶/|| button.**

The tracks are played in random order once.

To skip a track during playback, press the ▶▶ button or turn the JOG dial to the right to jump to the next track in the random sequence. Press the ◀◀ button or turn the JOG dial to the left to jump back to the start of a track being played.

To exit Random Play mode, press the RANDOM button to light off the "RANDOM" indicator after pressing the ■ button to stop the CD Player, press the ▲CD button to open the tray, or turn off the power.

Repeating Tracks

You can repeat the tracks or individual track as many times as you like.

Press the REPEAT button on the Remote Control.

The Repeat indicator changes with each press of the button, as shown below.

- ☞ → ☞ **ALL** → blank display → (back to the beginning)
- ☞ : Repeats one track.
- ☞ **ALL** : In Normal Play mode, repeats all the tracks. In Program Play mode, repeats all the tracks in the program. In Random Play mode, repeats all the tracks in random order.

To exit Repeat mode, press the REPEAT button until the Repeat indicator on the display goes out.

- In Random Play, as a matter of course, ☞ cannot be selected.
- Repeat mode remains in effect even when you change the play mode.

Using the MD Player (Listening to an MD)

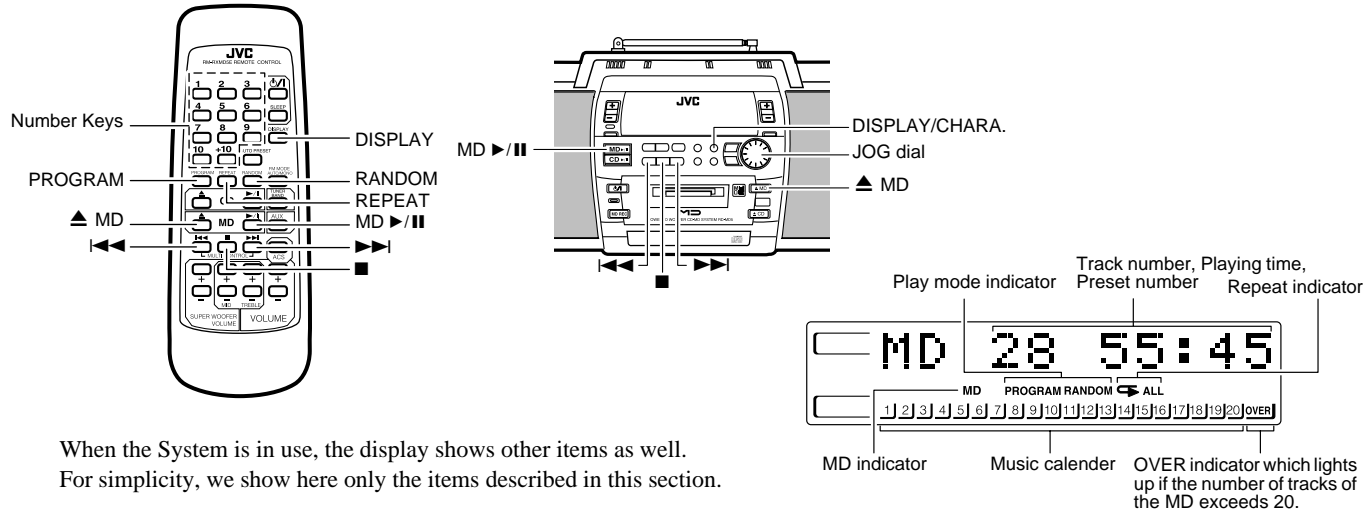

When the System is in use, the display shows other items as well. For simplicity, we show here only the items described in this section.

You can use Normal, Random, Program or Repeat Play in the same way as for CD Player. Repeat Play can repeat all the tracks or just one of the tracks on the MD.

Here are the basic things you need to know to play an MD and locate the different tracks on it.

The Quickest Way To Start an MD Is With the One Touch Operation

- Press the MD▶/|| button.
- The power is automatically turned on. If an MD is already inserted, it will start playing from the first track.
- If no MD is inserted, "MD NO DISC" appears on the display and the MD Player remains in Stop mode.

To Insert an MD

- Insert an MD into the MD slot. Insert it with its label side up and the ▷ or ⇒ mark of the MD directs as shown in the figure. The MD is automatically drawn inside the MD Player. When the function is set to MD, the display automatically changes as follows. Loading→TOC Reading→Disc title, if it is given→Total track number and total playback time (e.g.: MD 28 55:45)
- The music calendar also appears on the display.

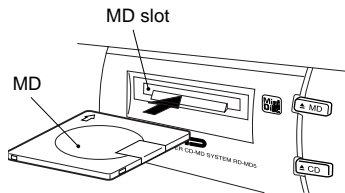

- You can insert an MD while listening to the other source.

Basics of Using the MD Player - Normal Play

To Play an MD

1. **Insert an MD.**
2. **Press the MD ▶/|| button.**
The first track of the MD begins playing.

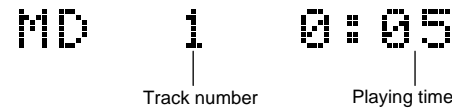

- The tracks in the MD appear on the music calendar.
- The track number that has been played disappears from the music calendar.
- The MD Player automatically stops when the last track of the MD has finished playing.
- If the track has the title, the track title will be displayed before playing the track. You can give the disc title and the track title as required. (See page 18.)

To stop playing the MD, press the ■ button. The following information for the MD is displayed after the disc title appears for 2 seconds if it is given.

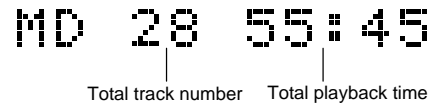

To stop playing and remove the MD, press the ▲MD button to eject the MD.

To pause, press the MD▶/|| button. The playback time blinks on the display.

To cancel pause, press the same button again. Play continues from the point where it was paused.

Displaying the Disc/Track Title

You can display the disc title of the MD in Stop mode and the track title during playback.

Displaying the Disc Title:

In Stop mode, press the DISPLAY/CHARA. button on the Unit or the DISPLAY button on the Remote Control. Each time you press the button, the display changes as follows.

Total track number and total playback time→Disc title→Remaining time (recordable capacity) of MD (e.g. REM. 23:00)→Clock→(back to the beginning)

During playing back, press the DISPLAY/CHARA. button on the Unit or the DISPLAY button on the Remote Control. Each time you press the button, the display changes as follows.

Track number and playback time for the track being played →Track title→Remaining time (recordable capacity) of MD (e.g. REM. 23:00)→Clock→(back to the beginning)

Locating a Track with Remote Control Directly

During playback or in Stop mode, press the number keys on the Remote Control to directly play a track.

To directly play the track 5, press 5.

To directly play the track 15, press +10 then 5.

To directly play the track 20, press +10 once then press 10.

To Select a Track

During playback, press the ◀◀ or ▶▶ button or turn the JOG dial to select the track you want.

The selected track starts playing.

- Press the ▶▶ button once or turn the JOG dial to the right by 1 click to skip to the beginning of the next track.
- Press the ◀◀ button or turn the JOG dial to the left by 1 click to skip to the beginning of the track being played. Press the ◀◀ button twice quickly or turn the JOG dial to the left by 2 clicks quickly to skip to the beginning of the previous track.

You can also select a track in Stop mode with the same buttons and the JOG dial.

When the button is pressed or the JOG dial is turned, the selected track and its playback time appear on the display. To play the MD after selecting a track, just press the MD▶/|| button.

Search Play

Holding down the ◀◀ or ▶▶ button, during playback, will fast forward/backwards the MD so you can quickly find a particular passage in the track you are listening to. During Search Play, you can hear the sound of approx. one forth level.

Programming the Playing Order of the Tracks

You can program the playing order of the tracks using the Remote Control.

- You can program up to 32 tracks in any desired order including the same tracks.
- You can only make a program when the MD Player is stopped.

- 1. Insert an MD.**
- 2. Press the MD▶/|| button.**
- 3. Press the ■ button to stop the MD.**
- 4. Press the PROGRAM button.**

The System enters the programming mode and the "PROGRAM" indicator lights up.



- 5. Press the number keys to select the track to program.**

To select the track 5, press 5.

To select the track 15, press +10 then 5.

To select the track 20, press +10 once then press 10.

- Example: for track 2, press 2.

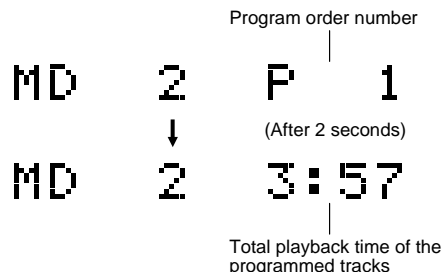

- 6. Repeat step 5 to select the other tracks for the program.**

You can see the total playback time of programmed tracks on the display. Also, you can see the programmed tracks on the music calender.

- To cancel the last track programmed, press the ■ button once.

- 7. Press the MD▶/|| button.**

The System plays the tracks in the order you have programmed them.

- You can skip to a particular program track by pressing the ◀◀ or ▶▶ button or by turning the JOG dial during Program Play.
- To stop playing, press the ■ button once.

To confirm the programmed tracks while the MD player is stopped, press the ◀◀ or ▶▶ button or turn the JOG dial; the tracks making up the program will successively be displayed in the programmed order.

To delete all the tracks in the program, press the ■ button repeatedly until all the tracks are cleared. Turning off the power or pressing the ▲MD button to eject the MD will also clear the programmed tracks.

To exit Program mode once, while the MD Player is stopped, press the PROGRAM button to light off the "PROGRAM" indicator. To restore Program mode, in Stop mode, press the same button to light on the "PROGRAM" indicator.

Notes:

- If the total playback time of the programmed tracks reaches 150 minutes, the total playback time will go out on the display.
- When you programmed the 21st track, the OVER indicator will light up.

To Modify the Program

Modify the contents of the program while the MD Player is stopped. Each time you press the ■ button, the last track in the program is deleted. To add new tracks to the end of the program, repeat above steps 5 and 6.

Random Play

The tracks will play in no special order when you use this mode.

- 1. Press the RANDOM button on the Remote Control.**

The "RANDOM" indicator lights up on the display.

- 2. Press the MD▶/|| button.**

The tracks are played in random order once.

To skip a track during playback, press the ▶▶ button or turn the JOG dial to the right to jump to the next track in the random sequence. Press the ◀◀ button or turn the JOG dial to the left to jump back to the start of a track being played.

To exit Random Play mode, press the RANDOM button to light off the "RANDOM" indicator after pressing the ■ button to stop the MD Player, press the ▲MD button to eject the MD, or turn off the power.

Repeating Tracks

You can repeat the tracks or individual track as many times as you like.

Press the REPEAT button on the Remote Control.

The Repeat indicator changes with each press of the button, as shown below.

- ↶ → ↶ **ALL** → **blank display** → (back to the beginning)
- ↶ : Repeats one track.
- ↶ **ALL** : In Normal Play mode, repeats all the tracks.
In Program Play mode, repeats all the tracks in the program.
In Random Play mode, repeats all the tracks in random order.

To exit Repeat mode, press the REPEAT button until the Repeat indicator on the display goes out.

- In Random Play, as a matter of course, ↶ cannot be selected.
- Repeat mode remains in effect when you change the play mode.

Recording onto an MD

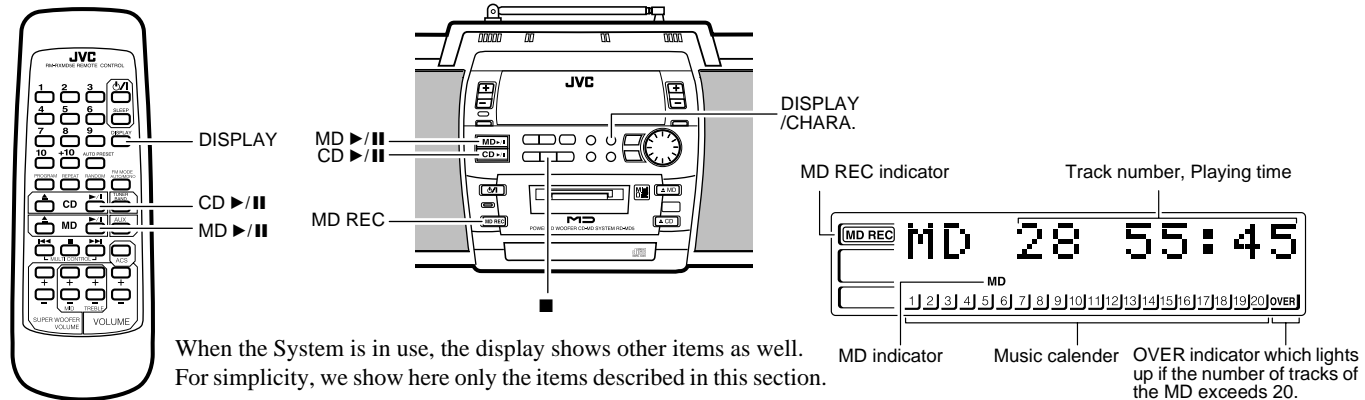

Recording onto an MD from any of the sound sources is simple. Just insert an MD to the Unit, have the source ready, make one or two settings, and you are ready to record. For each source, the procedure is a little bit different so we explain each separately. But first, here are a few things to make your recordings better.

Things To Know Before You Start

Recording

- It should be noted that it may be unlawful to re-record pre-recorded tapes, records, or discs without the consent of the owner of copyright in the sound or video recording, broadcast or cable programme and in any literary, dramatic, musical, or artistic work embodied therein.
- Carefully read the "Rules of Digital Dubbing" on page 24.
- The MD Recorder supports the following sampling frequency for the CD Player of the Unit as a digital source. Sampling frequency: 44.1 kHz.
- The recording level, which is the volume at which the new MD is being made, is automatically set correctly, so it is not affected by the VOLUME level of the System. Nor is it affected by adjusting the sound effects. Thus, during recording you can adjust the sound you are actually listening to without affecting the recording level.
- Note that it takes 10 seconds until the MD REC button becomes effective after the MD has been inserted.
- The accidental erasure prevention knob is provided on the back of an MD cartridge to prevent accidental erasure or recording. It must be set to the close position beforehand.

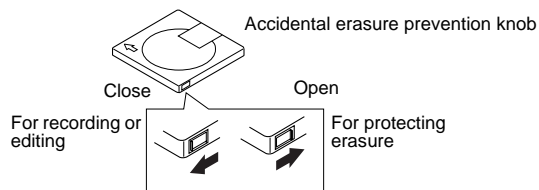

- When you stick an adhesive label onto the MD cartridge, adhere it securely. If it peels off, ejection trouble, etc. will occur.

Preparation Before Recording

- Be sure that the MD is not the Play-only type one.
- Be sure that the accidental erasure prevention knob of the MD cartridge is set to the close position. Otherwise, "DISC PROTECTED" will appear when you try to record a signal to the MD.
- Be sure that the MD has enough space for recording. If not, carry out ALL ERASE or ERASE function to erase all the tracks or desired tracks in the MD. (See pages 17 and 18.) You can check the recordable remaining time of the MD in Stop mode or during recording by pressing the DISPLAY/CHARA. button on the Unit or the DISPLAY button on the Remote Control.

(See "Checking the Remaining Time of the MD for CD Synchro Recording" mentioned on page 15.)

Standard Recording

You can record from the tuner or an auxiliary equipment to an MD as follows.

1. Insert a MD with its label side up.
2. Prepare one of the sources.

Tuner: Tune in to a station.

AUX IN: Press the AUX button and play the auxiliary equipment.

- For recording from the CD, see "CD Synchro Recording" on page 15.

3. Press the MD REC button on the Unit to start recording.

The "MD REC" indicator lights up on the display and the track number is increased by 1. When recording starts, the remaining time (recordable capacity) appears on the display.



4. Press the ■ button to stop recording.

The "MD REC" indicator goes out and "UTOCwriting" appears on the display, indicating that the recording is successfully completed. Then, the MD stops.

- If the MD becomes full before pressing the ■ button, the recording will be terminated after indicating "UTOCwriting".

To pause the recording, press the MD REC button on the Unit. The "MD REC" indicator starts blinking on the display and the track number is increased by 1 for the next recording.

To cancel pause, press the MD REC button on the Unit again. The "MD REC" indicator lights up on the display and recording resumes.

Checking the Remaining Time of the MD for Tuner/AUX Recording

You can see the recordable remaining time of the MD in Stop mode. In Stop mode, press the DISPLAY/CHARA. button on the Unit or the DISPLAY button on the Remote Control. Each time you press the button, the display changes as follows. Sound source → Remaining time (recordable capacity) of MD (e.g. REM. 23:00) → Clock → (back to the beginning)

Track Marking for Tuner/AUX Recording

- Whenever no sound at the playback side continues for 3 or more seconds, the track number at the MD side is automatically increased by 1.
- The track number at the MD side is automatically increased by 1 by pressing the SET button on the Unit at the desirable location.

CD Synchro Recording

Everything on the CD goes onto the MD in the order it is on the CD, or according to the order you have set in the program. (See page 10 for programming the CD tracks.)

- 1. Insert an MD with its label side up.**
- 2. Insert a CD. (See page 9.)**
- 3. Press the CD>/II button and then press the ■ button to stop the CD.**
- 4. Press the MD REC button on the Unit.**

The "MD REC" indicator lights up on the display and the track number is increased by 1.

Then the digital recording from the CD to the MD starts. The playback remaining time for the track being played and the remaining time of the MD appear on the display.

Playback remaining time of CD Remaining time of MD

3:57 > 55:44

- After the CD Player has played the entire CD or all the programmed tracks, "UTOCwriting" appears on the display, indicating that the recording is successfully completed. Then, the MD and the CD stops.
- When the MD becomes full before the CD Player finishes playback, the MD stops after indicating "UTOCwriting".

One Track Recording

- 1. Insert an MD with its label side up.**
- 2. Play the track on the CD you wish to record.**
- 3. Press the MD REC button on the Unit.**

The CD Player returns to the beginning of that track and the track is recorded on the MD. After recording, the CD Player and MD Player automatically stop.

Checking the Remaining Time of the MD for CD Synchro Recording

You can see the recordable remaining time of the MD in Stop mode or during the CD Synchro Recording.

In Stop mode, press the DISPLAY/CHARA. button on the Unit or the DISPLAY button on the Remote Control. Each time you press the button, the display changes as follows. Total track number and total playback time for the MD → Remaining time (recordable capacity) of MD (e.g. REM. 23:00) → Clock → (back to the beginning)

During the CD Synchro Recording, press the DISPLAY/CHARA. button on the Unit or the DISPLAY button on the Remote Control. Each time you press the button, the display changes as follows.

Playback remaining time for the CD's track being played and the remaining time of the MD → Track number of the CD and the MD (e.g.: CD 1>MD 19) → CD's track number and its playback time → Clock → (back to the beginning)

Track Marking for CD Synchro Recording

Whenever playback advances from one track to another, the track number at the MD side is automatically increased by 1.

Using the MD Player (Editing)

In addition to its recording and play functions, the MD Player comes with editing functions. You can divide, join, move, or erase the recorded tracks in the MD as required. Also, you can give a disc title to the MD and track titles to the tracks in the MD.

Dividing tracks (DIVIDE function)

This involves adding a track mark (see Note) at some point during the track which is to be made into the start of an additional track so that the original track is divided into two tracks.

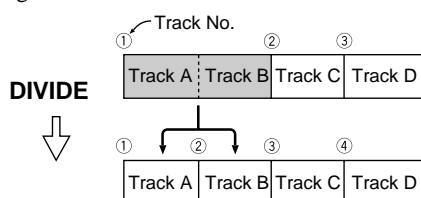

Joining tracks (JOIN function)

This involves erasing a track mark and turning two adjoining tracks into one track.

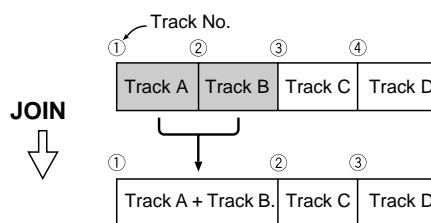

Moving tracks (MOVE function)

Tracks can be moved around so that they are in the desired sequence.

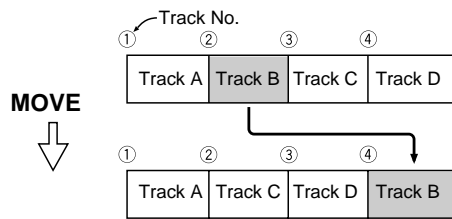

Erasing all the tracks (ALL ERASE function)

All the tracks can be erased at once without recording fresh material over them.

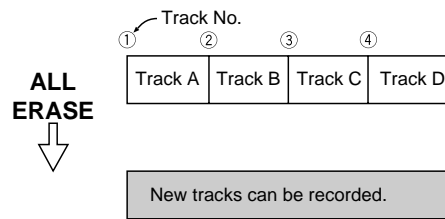

Erasing tracks (ERASE function)

This enables unnecessary tracks, Narration, etc. to be erased speedily. The erased parts do not remain as silences but are closed up by the subsequent tracks.

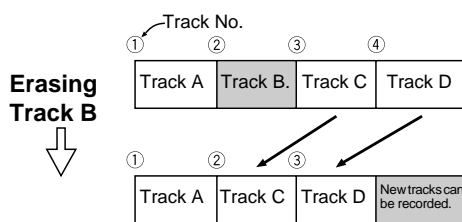

Giving titles to discs and tracks (TITLE function)

A title consisting of up to 32 characters can be given to a disc and a track. The title given appears in the display window.

Note: Track marks

These marks are provided to locate the start of each track. Whatever lies between one track mark and the next is considered to a track, and the numbers of the tracks (called "track numbers") are displayed in the sequence in which they are to be played.

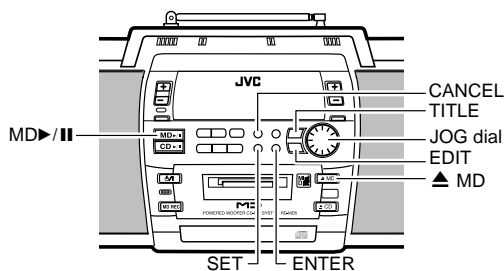

When the System is in use, the display shows other items as well. For simplicity, we show here only the items described in this section.

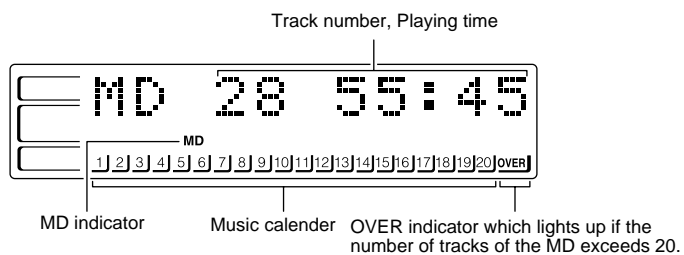

Dividing Tracks (DIVIDE Function)

Use the Unit to carry out this function.

1. Insert an MD to be edited with its label side up.

2. Press the MD>/II button and then ■ button to set the function to MD.

The track numbers and total playback time are displayed.

3. Press the EDIT button until "DIVIDE ?" is displayed.

Each time you press the button, the display changes as follows. Current display→DIVIDE→JOIN→MOVE→ERASE→ALL ERASE→(back to the beginning)

4. Press the SET button.

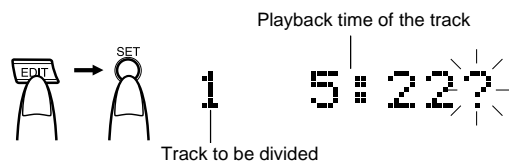

5. Select the track number to be divided.

Press the ◀◀ or ▶▶ button or turn the JOG dial to select the track.

The selected track is automatically played.

6. Press the SET button at the point where the track is to be divided.

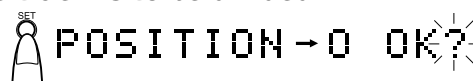

- The selected track is divided into two tracks and the track number in the music calendar will increase by 1.
- The recording lasting for 4 seconds starting where the track was divided is repeatedly played for your reference. Movement is possible within the POSITION-128 to 128 range (about 8 seconds before or after the position). Turn the JOG dial to adjust the position to be divided. The recording lasting for 4 seconds starting from the position to which the dividing point has been moved is repeatedly played.

7. Press the SET button.

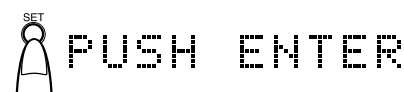

8. Press the ENTER button.

The selected track is divided into two tracks and the number of tracks increases by 1. The new total track number and the total playback time appear on the display.

9. Press the ▲MD button to complete editing.

The MD is ejected after "UTOCwriting" is displayed.

- You can also complete editing operation by pressing the button to turn off the power.

To cancel the operation, press the CANCEL button in step 4, 5, or 7 until the display returns to the original display before editing the track.

Note: While "UTOCwriting" is displayed, do not disconnect the power cord or subject the Unit to the vibration to avoid incorrect recording.

Joining Tracks (JOIN Function)

Use the Unit to carry out this function.

1. Insert an MD to be edited with its label side up.

2. Press the MD▶/II button and then ■ button to set the function to MD.

The track numbers and total playback time are displayed.

3. Press the EDIT button until "JOIN ?" is displayed.

Each time you press the button, the display changes as follows.

Current display→DIVIDE→JOIN→MOVE→ERASE→ALL ERASE→(back to the beginning)

4. Press the SET button.



5. Select the track number to be joined.

Press the ◀◀ or ▶▶ button or turn the JOG dial to select the track.

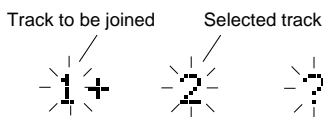

6. Press the SET button.



7. Press the ENTER button.

The selected track and the previous track are joined and the number of tracks decreases by 1. The new total track number and the total playback time appear on the display.

8. Press the ▲MD button to complete editing.

The MD is ejected after "UTOCwriting" is displayed.

- You can also complete editing operation by pressing the button to turn off the power.

To cancel the operation, press the CANCEL button in step 4, 5, or 6 until the display returns to the original display before editing the track.

Note: While "UTOCwriting" is displayed, do not disconnect the power cord or subject the Unit to the vibration to avoid incorrect recording.

Moving Tracks (MOVE Function)

Use the Unit to carry out this function.

1. Insert an MD to be edited with its label side up.

2. Press the MD▶/II button and then ■ button to set the function to MD.

The track numbers and total playback time are displayed.

3. Press the EDIT button until "MOVE ?" is displayed.

Each time you press the button, the display changes as follows.

Current display→DIVIDE→JOIN→MOVE→ERASE→ALL ERASE→(back to the beginning)

4. Press the SET button.

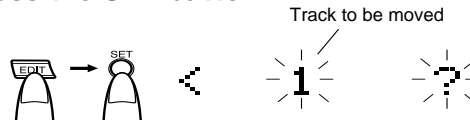

5. Select the track number to be moved.

Press the ◀◀ or ▶▶ button or turn the JOG dial to select the track.

Example: Track number 12.



6. Press the SET button.



7. Select the destination to which the track is to be moved.

To select the track number, press the ◀◀ or ▶▶ button or turn the JOG dial to select the track.

In this example, the 12th track will move to the 14th track.

(Since, the 12th track is lost, the upper tracks than the 12th one will be shifted toward the younger tracks.)

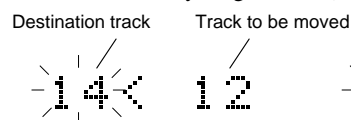

8. Press the SET button.



9. Press the ENTER button.

The selected tracks are moved. The total track number and the total playback time appear on the display.

10. Press the ▲MD button to complete editing.

The MD is ejected after "UTOCwriting" is displayed.

- You can also complete editing operation by pressing the button to turn off the power.

To cancel the operation, press the CANCEL button in step 4 through 8 until the display returns to the original display before editing the track.

Note: While "UTOCwriting" is displayed, do not disconnect the power cord or subject the Unit to the vibration to avoid incorrect recording.

Erasing Tracks (ERASE Function)

Use the Unit to carry out this function.

1. Insert an MD to be edited with its label side up.

2. Press the MD▶/|| button and then ■ button to set the function to MD.

The track numbers and total playback time are displayed.

3. Press the EDIT button until "ERASE ?" is displayed.

Each time you press the button, the display changes as follows.
Current display→DIVIDE→JOIN→MOVE→ERASE→ALL ERASE→(back to the beginning)

4. Press the SET button.

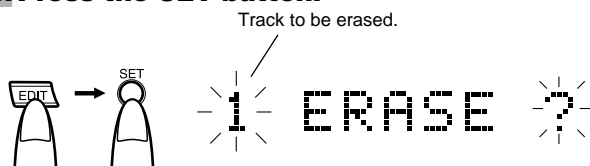

5. Select the track number to be erased.

Press the ◀◀ or ▶▶ button or turn the JOG dial to select the track.

6. Press the SET button.



7. Press the ENTER button.

The selected track is erased and the number of tracks decreases by 1. The new total track number and the total playback time appear on the display.

8. Press the ▲ MD button to complete editing.

The MD is ejected after "UTOCwriting" is displayed.
• You can also complete editing operation by pressing the ⏻ button to turn off the power.

To cancel the operation, press the CANCEL button in step 4, 5, or 6 until the display returns to the original display before editing the track.

Note: While "UTOCwriting" is displayed, do not disconnect the power cord or subject the Unit to the vibration to avoid incorrect recording.

Erasing all the Tracks (ALL ERASE Function)

■ Use the Unit to carry out this function.

1. Insert an MD to be edited with its label side up.

2. Press the MD▶/|| button and then ■ button to set the function to MD.

The track numbers and total playback time are displayed.

3. Press the EDIT button until "ALL ERASE ?" is displayed.

Each time you press the button, the display changes as follows.
Current display→DIVIDE→JOIN→MOVE→ERASE→ALL ERASE→(back to the beginning)

4. Press the SET button.



5. Press the ENTER button.

All the tracks in the MD are erased and "BLANK DISC" is kept displayed.

6. Press the ▲ MD button to complete editing.

The MD is ejected after "UTOCwriting" is displayed.

- You can also complete editing operation by pressing the ⏻ button to turn off the power.

To cancel the all erasing, press the CANCEL button in step 4.

Note: While "UTOCwriting" is displayed, do not disconnect the power cord or subject the Unit to the vibration to avoid incorrect recording.

Giving Titles to MD (DISC TITLE/TITLE Function)

You can give a disc title to the MD and a track title to the tracks in the MD. Any title name can be given up to 32 characters using the provided character sets.

The disc title you have given will be displayed in the following cases.

- When you insert the MD while the function is set to MD.
- When you press the MD▶/|| button and then ■ button to set the function to MD.

Once you have given the title to the tracks, the track title will be displayed before playing the track.

- Since the procedure to give title is the same as for the disc title and track title except for step 4, both functions are explained together here.
- Use the Unit to carry out these functions.

1. Insert an MD to be edited with its label side up.

2. Press the MD▶/|| button and then ■ button to set the function to MD.

The total track numbers and total playback time are displayed.

3. Press the TITLE button until "DISC TITLE ?/TITLE ? (for track title)" is displayed.

Each time you press the button, the display changes as follows.
Current display→DISC TITLE→TITLE→(back to the beginning)

4. Press the SET button.

- For DISC TITLE:

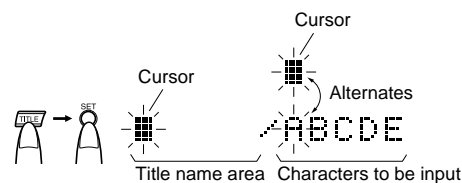

- For TITLE (Track Title):

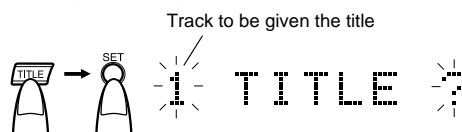

- ① Select the track number to be given the title by pressing the ◀◀ or ▶▶ button or turning the JOG dial.
- ② Press the SET button.

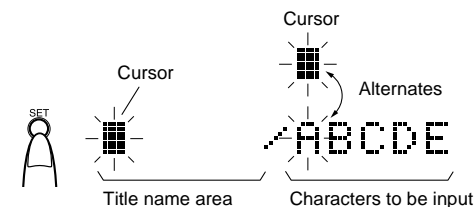

5. Input a preferred title (up to 32 characters).

Use the following buttons to input a title.
 [Title editing buttons and their functions] (see below)

Button	Function
DISPLAY /CHARA.	Changes the type of characters to be input as follows. Upper-case letters and symbols ↓ Lower-case letters and symbols ↓ Numbers
	Moves the cursor for the character to be input to the right. When you try to move the cursor over the characters on the display, five characters scroll at a time. (e.g. ABCDE → FGHIJ)
	Moves the cursor for the character to be input to the left. When you try to move the cursor over the characters on the display, five characters scroll at a time. (e.g. FGHIJ → ABCDE)
▶▶	Moves the cursor for the title name to the right.
◀◀	Moves the cursor for the title name to the left.

Example: When input the title "N(space)1"

1. Display the letter N to be input by turning the JOG dial to the right or left.
2. Select "N" (put the cursor to the letter N by turning the JOG dial to the right or left).
3. Press the SET button.

The letter N is now displayed in the title area.



4. Select "(space)" and press the SET button.
 5. Press the DISPLAY/CHARA. button until the numbers are displayed.
 6. Select "1" and press the SET button.
- The title name "N(space)1" will be displayed.

Editing the Title Name:

- If the wrong character has been input, clear it using the CANCEL button.
- To clear a particular character which has been input, use the ▶▶ or ◀◀ button to align the cursor with the character, and press the CANCEL button. Then, select the correct character and press the SET button.

6. Press the ENTER button.



7. Press the ENTER button again.

8. Press the ΔMD button to complete editing.

The MD is ejected after "UTOCwriting" is displayed.

- You can also complete editing operation by pressing the ⏻ button to turn off the power.

To cancel the operation, press the CANCEL button in step 6.
Note: While "UTOCwriting" is displayed, do not disconnect the power cord or subject the Unit to the vibration to avoid incorrect recording.

Giving a Track Title during Playback

You can give a track title during playback a track.

1. Press the TITLE button.

"TITLE ?" appears on the display.

2. Press the SET button.

3. Perform steps 5 - 8 mentioned above to give a track title.

Note: Give a title before playback of the track is ended.

[Character Layout Table]

You can write album or song names to a disc, using the following characters:

Uppercase letters					Lowercase letters					Numbers				
A	B	C	D	E	a	b	c	d	e	0	1	2	3	4
F	G	H	I	J	f	g	h	i	j	5	6	7	8	9
K	L	M	N	O	k	l	m	n	o					
P	Q	R	S	T	p	q	r	s	t					
U	V	W	X	Y	u	v	w	x	y					
Z					z									
(space)	!	''	#	\$	(space)	!	''	#	\$					
%	&	'	()	%	&	'	()					
*	+	,	-	.	*	+	,	-	.					
/	:	;	<	=	/	:	;	<	=					
>	?	@	_	`	>	?	@	_	`					

Listening to an Auxiliary Equipment

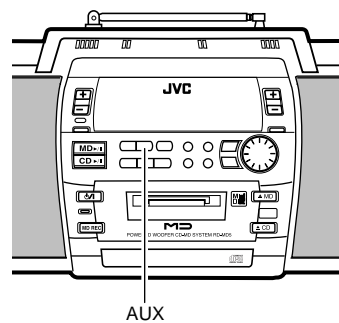
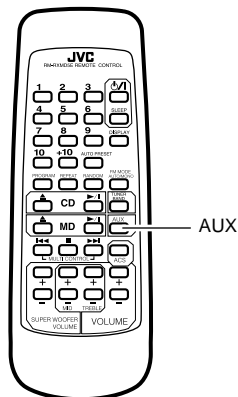

Listening to External Equipment

You can listen to an auxiliary equipment.

- First make sure that the auxiliary equipment is properly connected to the System.(See page 4).

1. Set the volume level to minimum.

2. Press the AUX button.

"AUX" appears on the display.

- To listen to the auxiliary equipment, start playing the auxiliary equipment.

3. Adjust the volume to the desired listening level.

4. Apply sound effects, if you wish.

- Adjust the super woofer volume to reinforce the bass sound.
- Press the ACS (ACTIVE CLEAR SOUND) button to activate the ACS effect. (See "ACS (Active Clear Sound) Effect" on page 6.)
- Press the MID/TREBLE button to control the tone. (See "Tone Control (MID/TREBLE)" on page 5.)

Note: For operation of the auxiliary equipment, refer to its Instructions.

Using the Timers

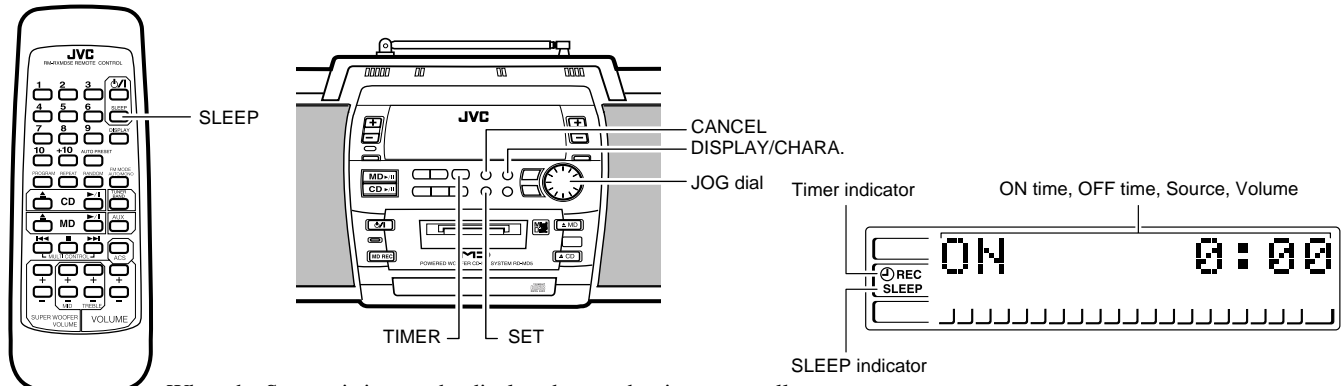

When the System is in use, the display shows other items as well. For simplicity, we show here only the items described in this section.

The timers let you control listening and recording functions automatically.

Setting the Clock

- When you plug the AC power cord into the wall outlet, the time indication blinks on the display.
- You can set the clock whether the System is on or off.
- Use the Unit to set the clock.

Notes:

- The clock must be correctly set for the timers to work.
- The procedure must be completed within two minutes. Otherwise, the setting is cleared and must be repeated from the beginning.

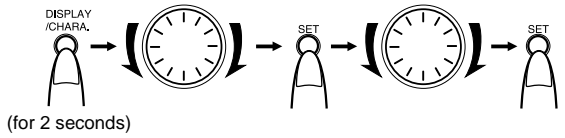

- 1. Press the DISPLAY/CHARA. button on the Unit for more than two seconds.**
The hour indication rapidly blinks on the display.
- 2. Turn the JOG dial to set the hour.**
Turn the JOG dial to the right or left to increase or decrease the hour. Turning it rapidly advances or decreases the hour faster.
- 3. Press the SET button.**
The minute indication rapidly blinks on the display.
- 4. Turn the JOG dial to set the minute.**
Turn the JOG dial to the right or left to increase or decrease the minute. Turning it rapidly advances or decreases the minute faster.
- 5. Press the SET button.**
The selected time is set and the seconds start counting from 0.

CAUTION: If there is a power failure, the clock loses its setting after about 5 minutes. "0:00" blinks on the display and the clock must be reset.

Setting the Daily Timer

Once you have set the Daily Timer, the timer will be activated at the same time every day. It can be cancelled and reactivate whenever you wish.

The Timer indicator on the display shows when the Daily Timer you have set is in effect.

Use the Unit to set the Daily Timer.

Note: Perform each setting within 30 seconds. Otherwise, setting is cleared and the procedure must be repeated from the beginning.

- 1. Press the O/I button to turn on the System.**
- 2. Setting the ON time (Example: 12:15).**

1. Press the TIMER button.
The Timer indicator lights up and the hour of the current ON time blinks on the display.



2. Turn the JOG dial to set the hour you want the Unit to come on.
Turn the JOG dial to the right or left to increase or decrease the hour. Turning it rapidly advances or decreases the hour faster.



3. Press the SET button.
The minute of the current ON time blinks on the display.

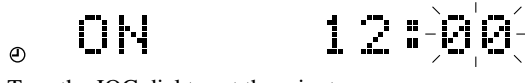

4. Turn the JOG dial to set the minute.



5. Press the SET button.
The hour of the current OFF time blinks on the display.



- 3. Setting the OFF time (Example: 13:15).**

1. Turn the JOG dial to set the hour you want the Unit to be turned off.



2. Press the SET button.

The minute of the current OFF time blinks on the display.

② OFF 13:00

3. Turn the JOG dial to set the minute.

② OFF 13:15

4. Press the SET button.
The music source "TUNER" blinks on the display.

4. Selecting the music source.

- Turn the JOG dial to select the music source you want to listen to. The display changes as shown below.
TUNER→TUNER REC→CD→MD→(back to the beginning)
 - When you select the "TUNER REC", the "REC" indicator appears on the display.
- Press the SET button.
The current volume setting blinks on the display.

5. Setting the volume level.

- Turn the JOG dial to select the volume level.
-- : The current volume level will be used.
0 to 50: When the timer is turned on, the Volume will be automatically set to the selected level.

② VOLUME 15

- Press the SET button.
The timer setting is completed and the display returns to the display before you set the timer. The Timer indicator remains lit.

6. Before turning off the System, prepare the music source selected in step 4.

TUNER: Tune in to the desired station.

TUNER REC: Tune in to the desired station and insert an MD for recording the station.

CD: Insert a CD.

MD: Insert an MD.

7. Press the button to turn off the System.

To cancel the operation, press the CANCEL button in steps 2-4 and 5-1. Each time you press the CANCEL button, the display returns to the previous step one.

To cancel the timer, press the TIMER button. The Timer indicator goes out on the display.

To reactivate the cancelled timer, press the TIMER button to light the Timer indicator. Then, press the SET button until the display returns to the original display.

To confirm the timer settings, press the TIMER button twice to cancel and reactivate the timer. Then, press the SET button repeatedly to see the current timer settings (ON time, OFF time, source, and volume).

To change the timer setting, repeat the setting procedure from the beginning.

- When the timer turns on, the Timer indicator starts blinking and the volume level gradually increases from 0 (zero) to the preset level, except when you set the volume level to "--" in step 5.

CAUTION: If the System is unplugged, or a power failure occurs, the timer setting will be lost. You will need to reset the clock first, then the timer.

Setting the SLEEP Timer

Use the Sleep Timer to turn the System off after a certain number of minutes when it is playing. By setting the Sleep Timer, you can fall asleep to music and know that your System will turn off by itself rather than play all night.

■ You can only set the Sleep Timer when the System is on and a source is playing.

1. Play a CD, MD, or tune in to the desired station.

2. Press the SLEEP button on the Remote Control.

"SLEEP" appears on the display. SLEEP 30

3. Set the length of time you want the source to play before shutting off.

- Each time you press the SLEEP button, it changes the number of minutes shown on the display in this sequence:
→ 30 → 60 → 90 → 120 → Cancelled (Original display) → (back to the beginning)

After setting the number of minutes for the Sleep Timer, the display will stop blinking and return to the display as before setting the Sleep Timer. **(The display is dimmed.)**

The System is now set to turn off after the number of minutes you set.

To Confirm the Sleep Time

When the SLEEP button is pressed, the remaining sleep time is displayed. Wait until the display returns to the original display.

To Cancel the SLEEP Timer Setting

Press the SLEEP button until the original display appears on the display. Turning off the System also cancels the SLEEP Timer.

- If you are setting the Daily Timer, the System will be turned on at the set time to wake you up.

Information on MDs (Minidiscs)

This is a new digital audio disc format: it has a diameter of 64 mm and enables up to 74 minutes of playback and recording.

The cartridge

The diameter of the disc itself is 64 mm, smaller than a CD single. The disc sits inside a 68 × 72 mm cartridge, which also being pocket size, makes minidiscs extremely handy for carrying and storage. Since the disc is protected by the cartridge, dust and dirt cannot easily get into it. And thanks to a shutter which is closed at all times except during use, there is no need to worry about scratches or finger marks, making the handling of minidiscs very simple.

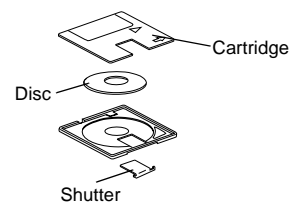

Two types of minidisc

There are two types of minidisc, "recordable MDs" and "playback-only MDs." The playback method for each is the same: a laser irradiates the disc and the signal is read from the beam which comes back. However, the recording method for each type is different.

Playback-only MD

This is the type used for commercially-available pre-recorded MDs, on which recording cannot be done. Like a CD, data is recorded based on the presence or absence of small indentations called pits. A disc recorded with this format is called an "optical disc."

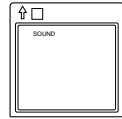

Recordable MDs

These are the so-called "blank" MDs you can use to make your own recordings. Data is recorded by magnetism, which is easily processed, so that recording can be done again and again. By using a laser to heat the disc, the magnetism is erased and the magnetic head records the new data. Discs with this type of recording method are called magneto-optical (MO) discs.

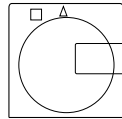

ATRAC (Adaptive Transform Acoustic Coding)

Within recordings, there are sounds which cannot be readily heard. For example, as the volume decreases, high-pitched sounds and low-pitched sounds become difficult to hear. Also, if a quiet sound comes at the same time as or just after a loud sound, it will not be heard. With minidisks, data is compressed using a technology called ATRAC (Adaptive Transform Acoustic Coding) which selectively chooses sounds based on human sense of hearing characteristics. With this technology, the recorded data is about one-fifth the volume of the original data, allowing it to fit on a compact minidisc.

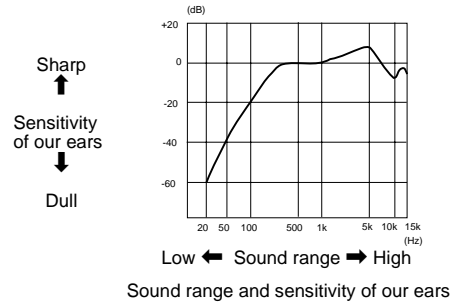

Sound skip guard memory

With the minidisc, the data of the track being played can be temporarily stored up using a function called "sound skip guard memory". Even when data cannot be collected properly from the disc due to shaking or vibrations, information is stored in the "sound skip guard memory", so that there is no break in the sound which is actually delivered.

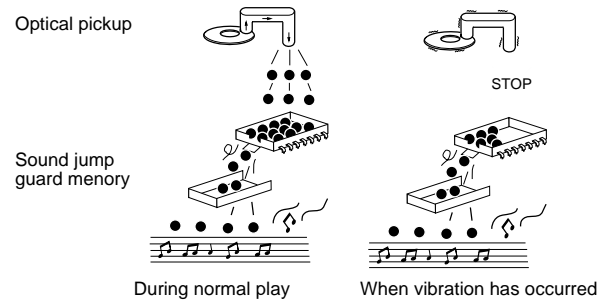

UTOC (User Table Of Contents)

In a minidisc, apart from the recorded tracks, there is the "UTOC". In this area, information such as the position where each track is recorded, the track divisions, and track order are listed. When music search is done, the UTOC is consulted, and the tracks are quickly found and played back. When editing is done, only the UTOC is changed, so there is no need to re-record the tracks.

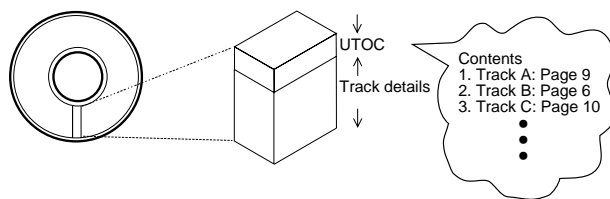

MD Messages

Message	Meaning	Action
BLANK DISC	A disc has been inserted with nothing recorded on it.	Except when making a new recording, replace the disc with one which has been recorded on.

Message	Meaning	Action
CANNOT JOIN	You have tried to join tracks which cannot be joined.	This is a limitation of the minidisc system. See "Minidiscs limitations" on page 24.
DISC ERROR	There is a problem (damage) with the disc.	Replace the disc.
DISC FULL	There is not enough space left on the disc. There are over 254 tracks.	Replace the disc with another recordable MD.
DISC PROTECTED	The disc is in accidental erasure protection mode.	Slide the accidental erasure protection tab. (So that the hole is covered.)
EMERGENCY STOP	A malfunction occurred during recording.	Stop the disc by pressing the ■ button and redo the operation.
NO DISC	There is no disc in the unit.	Insert a disc into the unit.
NON AUDIO CANNOT COPY	You have tried to digitally dub a CD-ROM	Stop recording.
PLAYBACK MD	You have tried to record or edit on a playback-only disc.	Replace the disc with a recordable MD.
TRACK PROTECTED	The track is protected.	This unit cannot undo track protection. Undo the protection using the appliance that created it.

Minidisc limitations

The minidisc records information in an original format that differs from that of conventional cassette tapes or DATs. Since there are some limitations with this recording format, the following types of conditions may arise. These conditions are not malfunctions.

Condition	Cause
"DISC FULL" is displayed, even though the possible recording time is not used up.	With the minidisc, there is a maximum number of tracks which can be recorded, regardless of time. More than 254 tracks cannot be recorded on a disc.
"DISC FULL" is displayed, even though the number of tracks and recording time are not at the limit.	When parts of the disc are erased and re-recorded, blank spots are created on the disc. When recording to such a disc, one track of data is divided and recorded in the blank areas. During recording, when these divided parts become numerous, the "DISC FULL" message may be displayed. When a part of 8 seconds or less is created by division, that track cannot be joined by the JOIN function, and even if it is erased, the remaining usable time on the disc does not increase. Tracks divided into small pieces may skip when fast forward or fast rewind is done.
The JOIN function sometimes doesn't work.	
The remaining usable time on the disc doesn't increase even when tracks are erased.	
The sound skip during fast forward or fast rewind.	Minidiscs must have at least 2 seconds of continuous space in order to record. For this reason, the actual recording time of discs with a lot of short blank areas becomes shorter.
The amount of recorded time on the disc added to the amount of remaining time falls short of the disc's total possible recording time.	

Rules of Digital Dubbing

The following rules regarding copyright exist for dubbing to MDs from CDs or DATs through digital terminals.

SCMS (Serial Copy Management System)

Minidiscs can record clear sound with low loss of quality from CDs or DATs through each component's digital input/output terminal. However, minidiscs are set up so that a disc recorded in this way cannot be recorded onto another minidisc through digital input/output terminals. In other words, you can not make a copy of a copy. This rule is called SCMS (Serial Copy Management System).

The recorder is designed in compliance with this rule. If you try to make a copy of a copy error message "SCMS CANNOT COPY" is displayed, and dubbing can not be done.

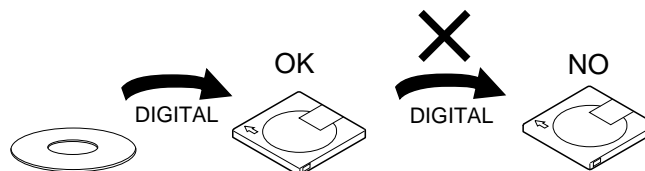

It should be noted that it may be unlawful to re-record pre-recorded tapes, records, or discs without the consent of the owner of copyright in the sound or video recording, broadcast or cable programme and in any literary, dramatic, musical, or artistic work embodied therein.

Care And Maintenance

Handle your CDs and MDs carefully, and they will last a long time.

Compact Discs



- Only CDs bearing this mark can be used with this System. However, continued use of irregular shape CDs (heart-shape, octagonal, etc.) can damage the System.



- Remove the CD from its case by holding it at the edges while pressing the case's center hole lightly.
- Do not touch the shiny surface of the CD, or bend the CD.

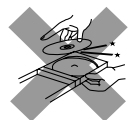

- Put the CD back in its case after use to prevent warping.
- Be careful not to scratch the surface of the CD when placing it back in the case.
- Avoid exposure to direct sunlight, temperature extremes, and moisture.



- A dirty CD may not play correctly. If a CD does become dirty, wipe it with a soft cloth in a straight line from center to edge.

CAUTION: Do not use any solvent (for example, conventional record cleaner, spray thinner, benzine, etc.) to clean a CD.

MDs (Minidisks)

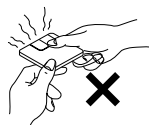

- Do not open the shutter. Since the shutter is locked to prevent it from opening, forcing it to open will break the disc.
- Avoid exposure to direct sunlight, temperature extremes, and moisture.

Moisture Condensation



Moisture may condense on the lens inside the System in the following cases:

- After turning on heating in the room.
- In a damp room.
- If the System is brought directly from a cold to a warm place.

Should this occur, the System may malfunction. In this case, leave the System turned on for a few hours until the moisture evaporates, unplug the AC power cord, and then plug it in again.

General Notes

In general, you will have the best performance by keeping your CDs and MDs.

- Store CDs and MDs in their cases, and keep them in cabinets or on shelves.
- Keep the system's CD tray closed when not in use.

Troubleshooting

- If you are having a problem with your System, check this list for a possible solution before calling for service.
- If you cannot solve the problem from the hints given here, or the System has been physically damaged, call a qualified person, such as your dealer, for service.

Symptom	Possible Cause	Action
No sound is heard.	<ul style="list-style-type: none"> • Connections are incorrect, or loose. • Headphones are connected. 	<ul style="list-style-type: none"> • Check all connections and make corrections. (See pages 3 and 4.) • Disconnect the headphones.
Poor radio reception	<ul style="list-style-type: none"> • The antenna is disconnected. • The AM Loop Antenna is too close to the System. • The FM telescopic antenna is not properly extended and positioned. 	<ul style="list-style-type: none"> • Reconnect the antenna securely. • Change the position and direction of the AM Loop Antenna. • Fully extend the FM telescopic antenna and turn it for the best reception.
The CD skips.	The CD is dirty or scratched.	Clean or replace the CD.
The CD does not play.	The CD is upside down.	Put the CD in with the label side up.
The MD cannot be inserted.	An MD has already been inserted.	Press the ▲MD button to eject the inserted MD and insert a new MD.
Recording cannot be made on MD.	The accidental erasure prevention knob of the MD is set to the open position.	Set it to the close position.
Timer fails to start.	Present time is not correct.	Set the time correctly.
Unable to operate the Remote Control.	<ul style="list-style-type: none"> • The path between the Remote Control and the sensor on the Unit is blocked. • The batteries have lost their charge. 	<ul style="list-style-type: none"> • Remove the obstruction. • Replace the batteries.
Operations are disabled.	The built-in microprocessor has malfunctioned due to external electrical interference.	Unplug the System then plug it back in.

Specifications

Amplifier

Output Power (Max.)
 8.6 W (4.3 W + 4.3 W) at 4 ohms (full range)
 26.4 W (13.2 W + 13.2 W) at 4 ohms, 60Hz (woofer)
 (10% THD)
 7 W (3.5 W + 3.5 W) at 4 ohms (full range)
 21W (10.5 W + 10.5 W) at 4 ohms, 60Hz (woofer)

Input Sensitivity/Impedance (1 kHz)
 AUX IN 500 mV/47 kohms
 Output Sensitivity/Impedance (1 kHz)
 Phones 16 ohms - 1 kohms
 0 - 11 mW/ch output into 32 ohms

MD Player

Wow And Flutter Unmeasurable

CD Player

Wow And Flutter Unmeasurable

Tuner

FM Tuner
 Tuning Range 87.5 - 108.0 MHz
 AM Tuner
 Tuning Range (MW) 522 - 1,629 kHz
 (LW) 144 - 288 kHz
 Antenna FM telescopic antenna
 AM loop antenna

Speakers

Full range 7 cm × 2, 4 ohms
 Super woofer 10 cm × 2, 4 ohms

General

Dimensions 636 × 221 × 296 mm (W/H/D)
 Mass Approx. 10.2 kg

Accessories

Power Cord (1)
 AM Loop Antenna (1)
 Remote Control (1)
 Batteries R6P (SUM-3)/AA (15F) (2)

Power Specifications

Power Requirements AC 230 V ~, 50 Hz
 Power Consumption 40 watts (power on mode)
 7 watts (in Standby mode)

*Design and specifications are subject to change without notice.
 US and foreign patents licensed from Dolby Laboratories Licensing Corporation.*

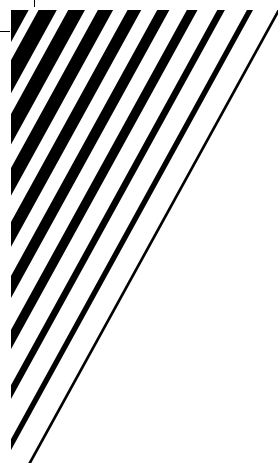

JVC
VICTOR COMPANY OF JAPAN, LIMITED